

Creston PR02 Relay Ports

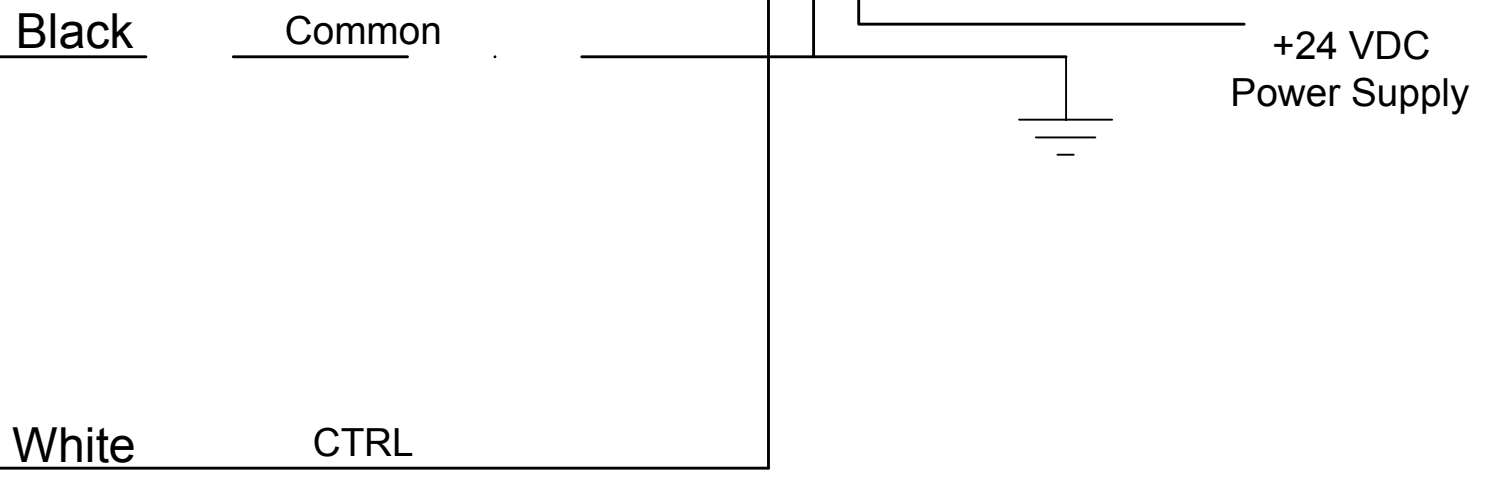

©2006 VECTOR SKETCH THE INFORMATION AND DESIGNS CONTAINED IN THIS DRAWING ARE CONFIDENTIAL AND THE PROPRIETARY PROPERTY OF VECTOR SKETCH LLC. NEITHER THIS DESIGN NOR ANY INFORMATION CONTAINED IN THIS DRAWING MAY BE REPRODUCED OR USED TO OTHERS WITHOUT THE EXPRESS WRITTEN CONSENT OF VECTOR SKETCH LLC.

431 Quiet Field Dr.
St. Peters, MO, 63376
636-294-2261

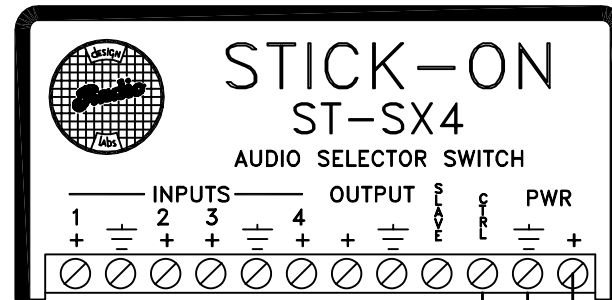
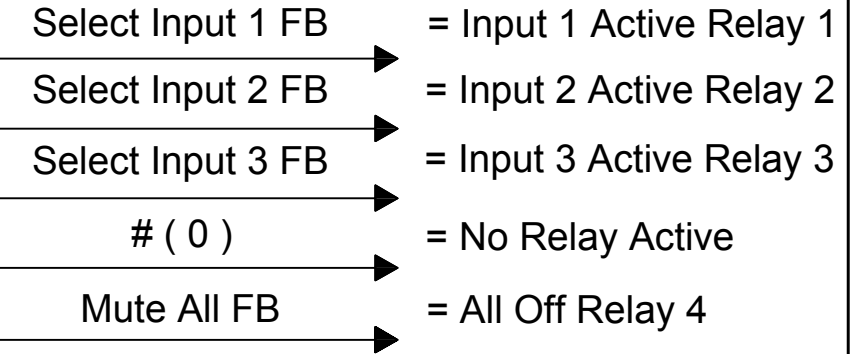
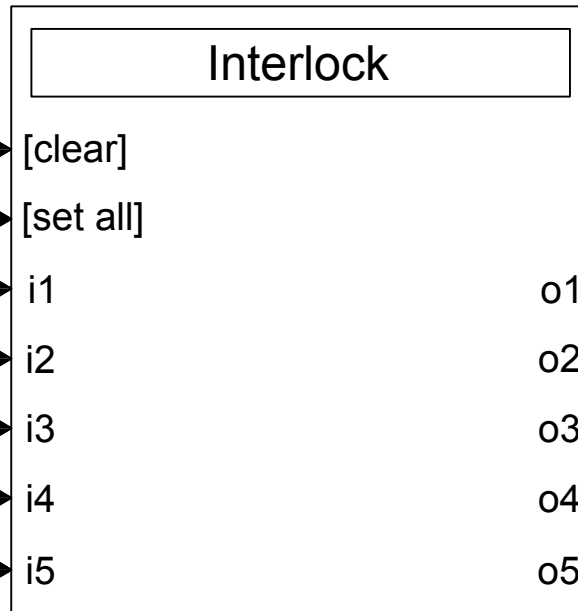
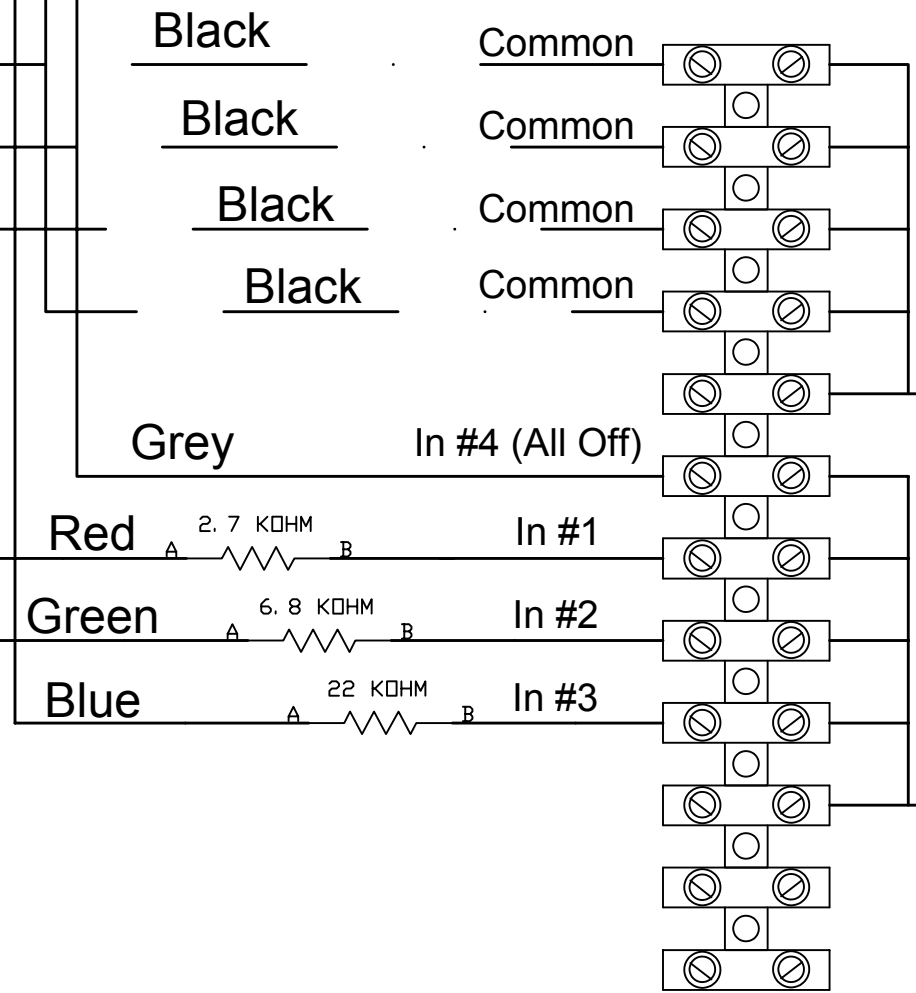
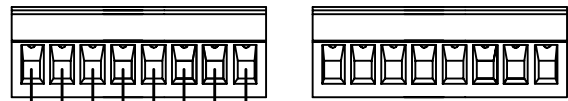
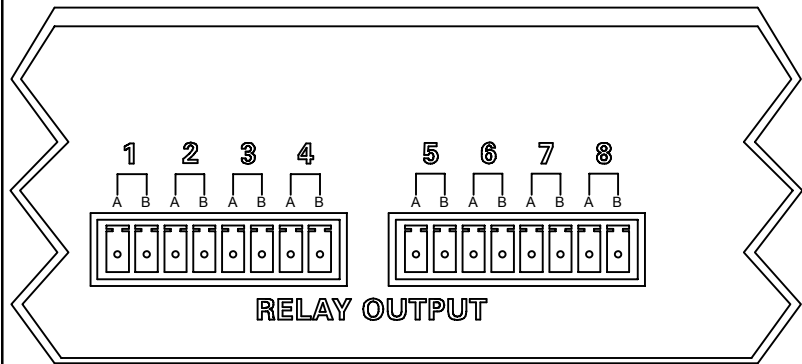

detail drawing	Pin-Out Drawing Example			
	Detail Wiring for Custom Control			
Approvals	Date	Revision	Paper Size	Scale
Drawn: ABOYD	11/15/05	A	B	none
Checked: ABOYD	11/15/05			
Modified: ABOYD	11/15/05			
Final: ABOYD	11/15/05			
				Sheet 1 of 1